

REV
B DT15-12P*-B016

REVISIONS			
SYM	DESCRIPTION	DATE	APPROVED
NC	NEW RELEASE PER E.O. P18012	1/16/03	R.D.R.
A	REVISED PER E.O. P19187	6/22/06	R.D.R.
B	REVISED PER E.O. P21065	8-26-11	ADR

3D VIEW

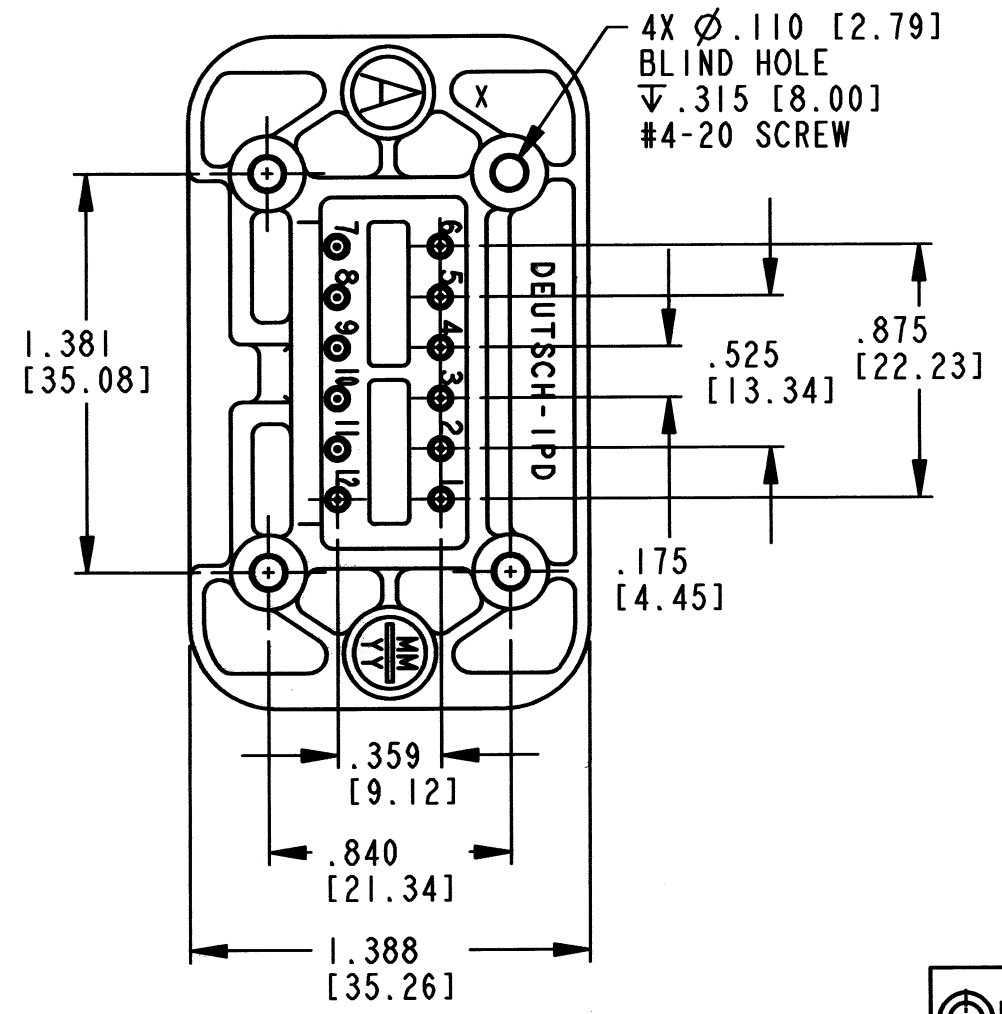
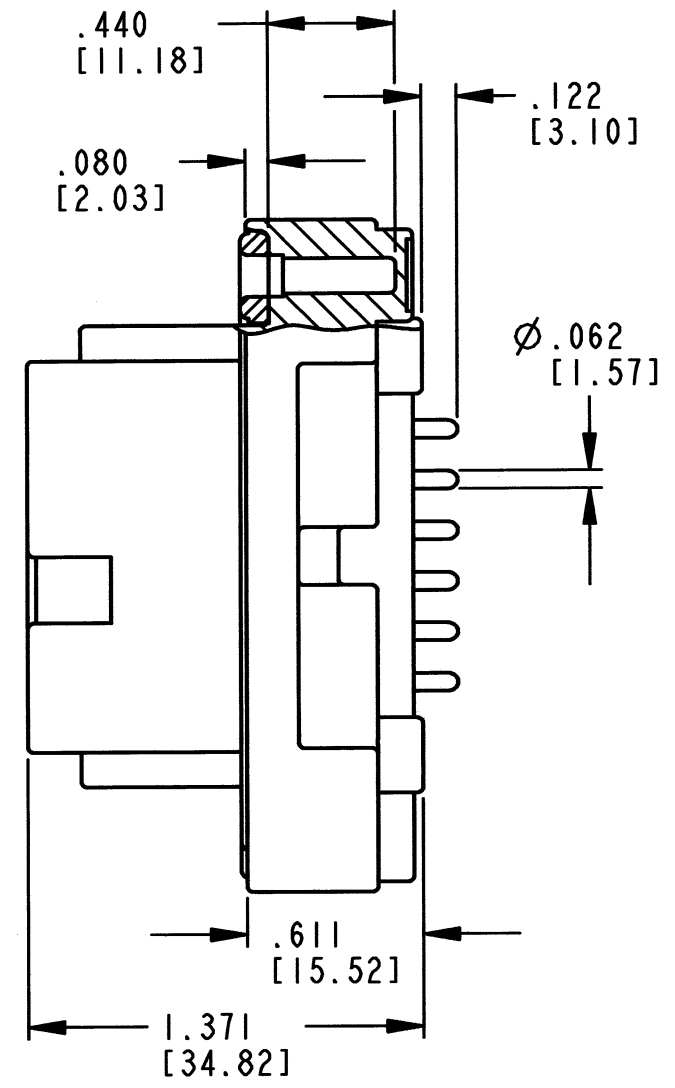
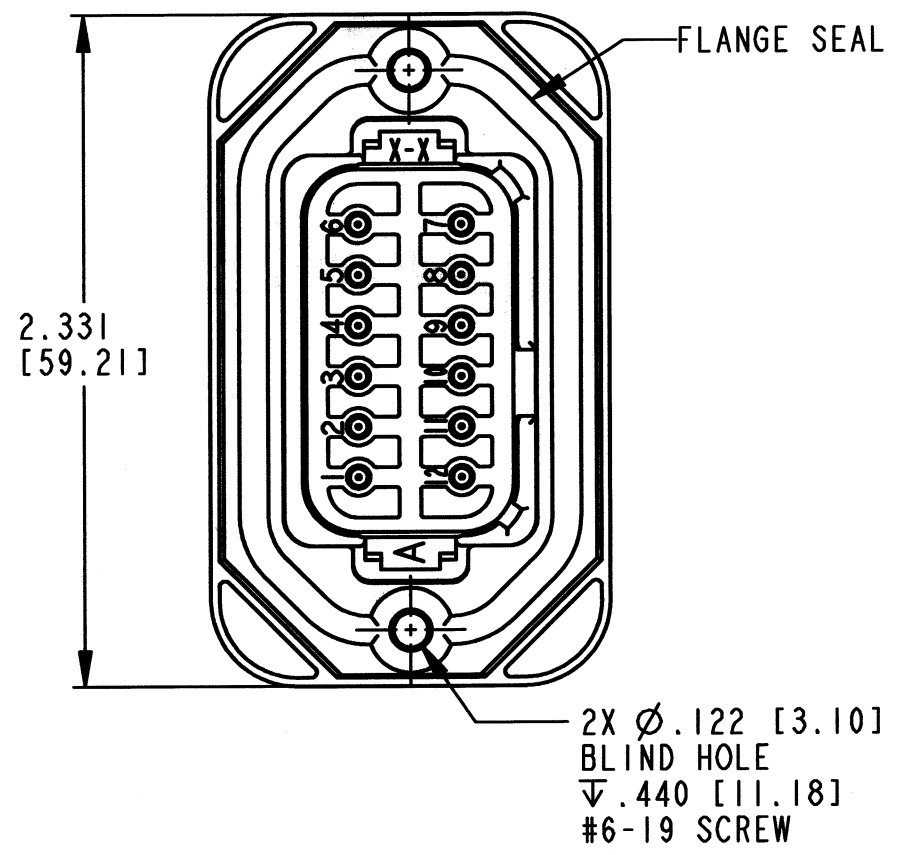
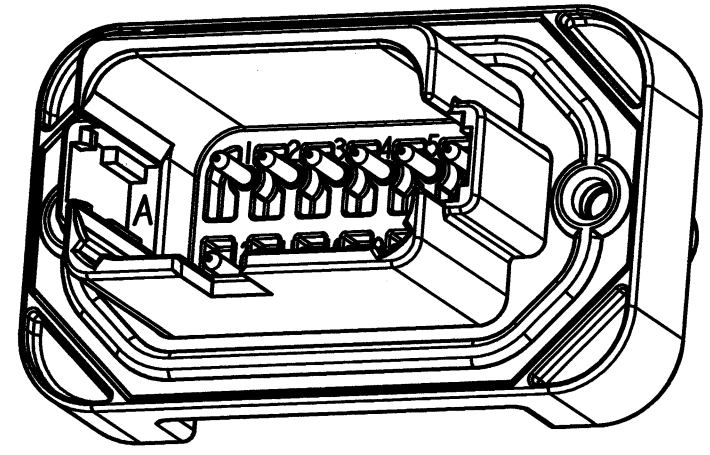

6. RECOMMENDED TORQUE VALUES ARE AS FOLLOWS: #6-19 SCREWS: 10-20 IN LB. [1.13-2.26 N m]. #4-20 SCREWS: 6-10 IN LB. [.68-1.13 N m].
5. MOUNTING HOLES WILL ACCEPT CAMCAR PLASTITE SELF THREAD SCREWS (NOT INCLUDED). EXAMPLE: #6-19, #4-20.
4. THIS RECEPTACLE MATES WITH DT06-12S* PLUG -****- ALL MODIFICATIONS
3. SHELL MATERIAL: PLASTIC; FLANGE SEAL MATERIAL: RUBBER.
2. DIMENSION TOLERANCE ±.025 [.64]. FOR PANEL CUTOUTS ±.010 [.25].
1. DIMENSIONS SHOWN ARE IN INCHES [MM].

NOTES:

SIGNATURE & DATE	
DR	P. BURKE 1/8/03
CHK	B. Byford 8/26/2011
PE	K. Klee 8/15/11
APPD	S. Baum 8/25/11
SCALE	NONE
WT	

PCB MOUNT RECEPTACLE
12 PIN STRAIGHT TAILS
B016 MOD
DT SERIES

ENVELOPE

EP	MATL. CODE
 3850 INDUSTRIAL AVE. HEMET, CA 92545 DEUTSCH INDUSTRIAL	
B	DT15-12P*-B016
DWG SIZE	CODE 11139 SHEET 1 OF 2

REV
B DT15-12P*-B016

REVISIONS			
SYM	DESCRIPTION	DATE	APPROVED
B	SEE SHEET ONE	8-26-11	ADR

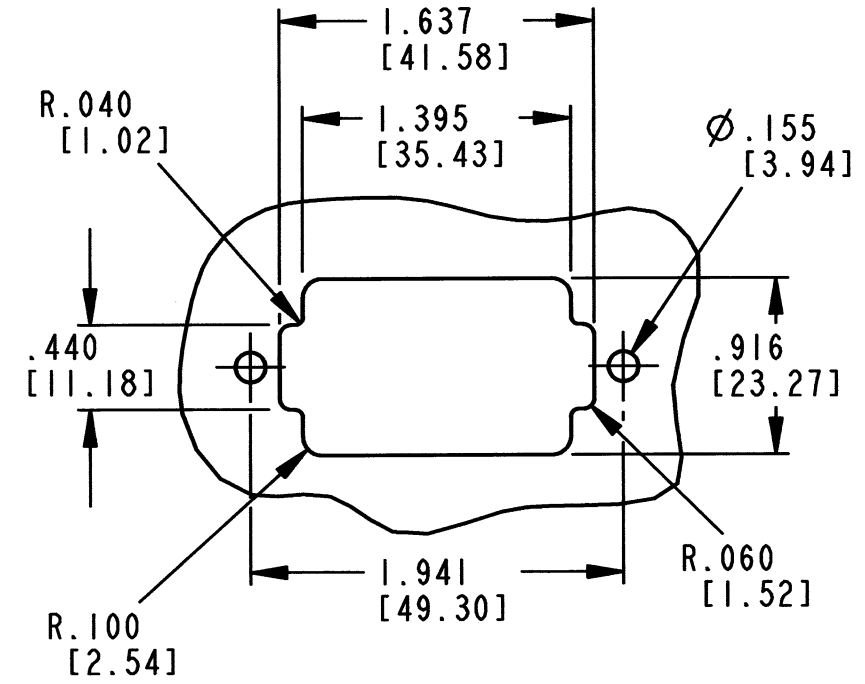
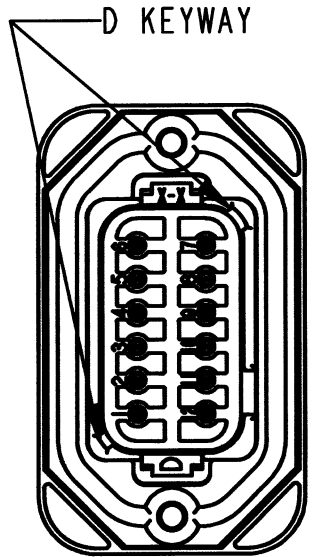
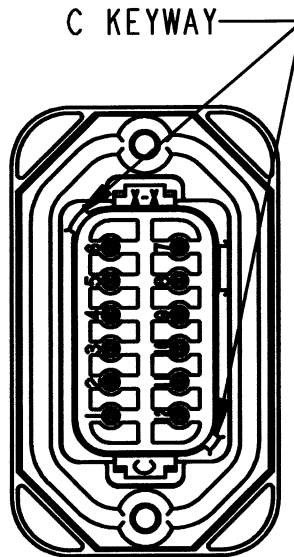
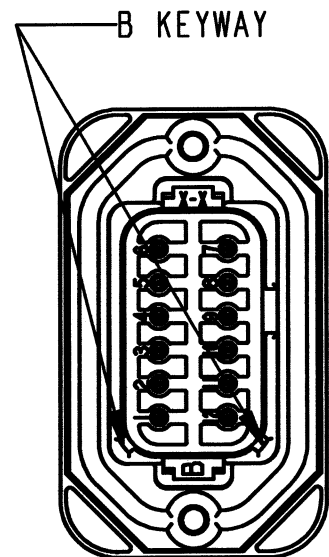
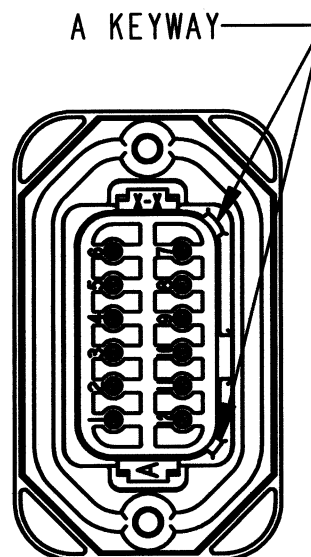

DATE CODE

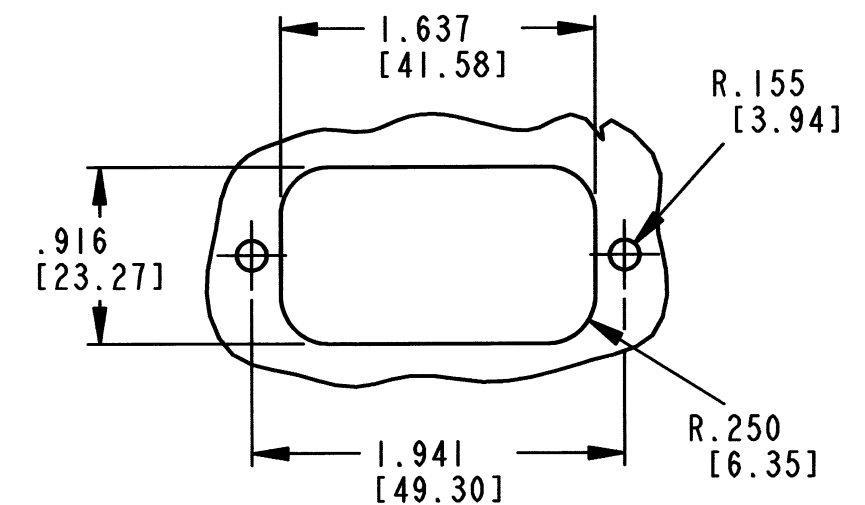
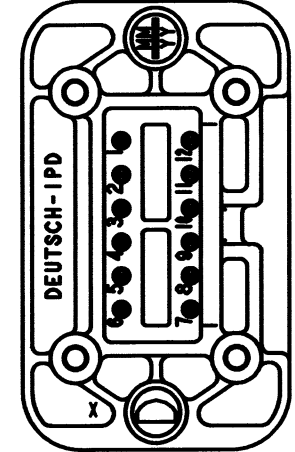
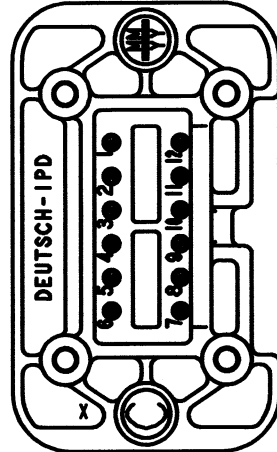
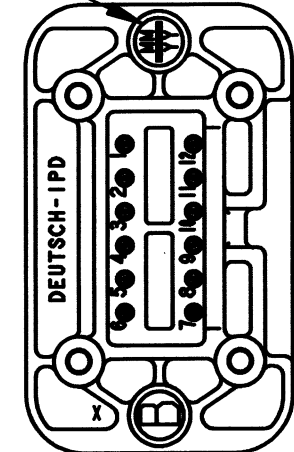
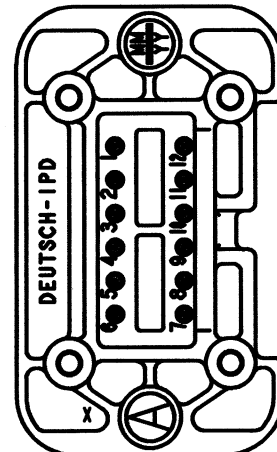

DT15-12PA-B016
COLOR: GREY

DT15-12PB-B016
COLOR: BLACK

DT15-12PC-B016
COLOR: GREEN

DT15-12PD-B016
COLOR: BROWN

NOTES: SEE SHEET ONE

SIGNATURE & DATE	
DR	P. BURKE 1/18/03
CHK	<i>[Signature]</i> 8/26/2011
PE	<i>[Signature]</i> 8/15/11
APPD	<i>[Signature]</i> 8/25/11
SCALE	NONE WT

PCB MOUNT RECEPTACLE
12 PIN STRAIGHT TAILS
B016 MOD
DT SERIES

ENVELOPE

EP	MATL. CODE
3850 INDUSTRIAL AVE. HEMET, CA 92545	
B	DT15-12P*-B016
DWG SIZE	CODE 11139 SHEET 2 OF 2