

1434-26 - VIEW FROM TOP (SOLD SEPERATELY)

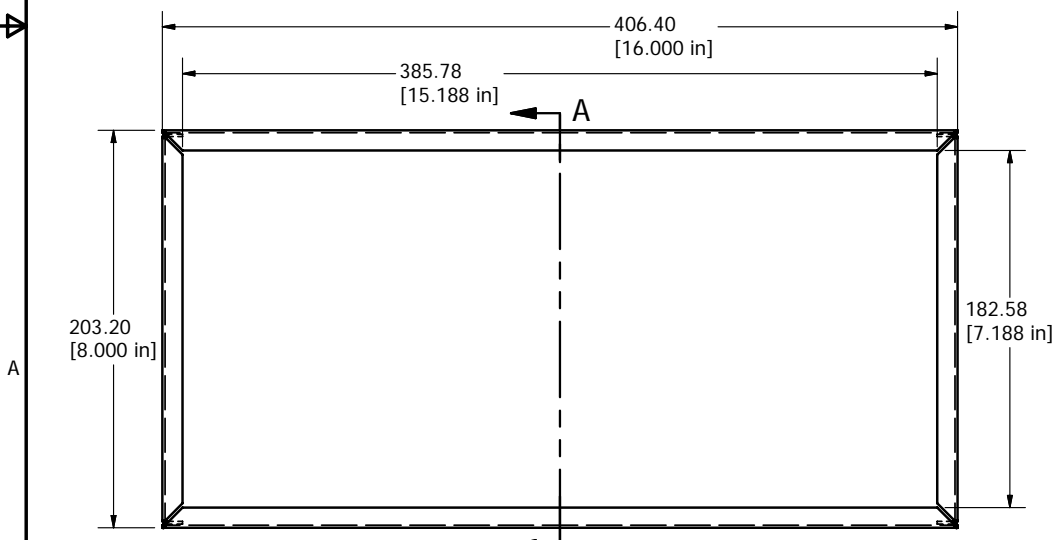

1444-28 - VIEW FROM TOP (SOLD SEPERATELY)

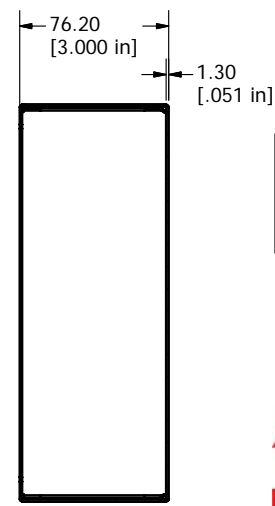

SECTION A-A

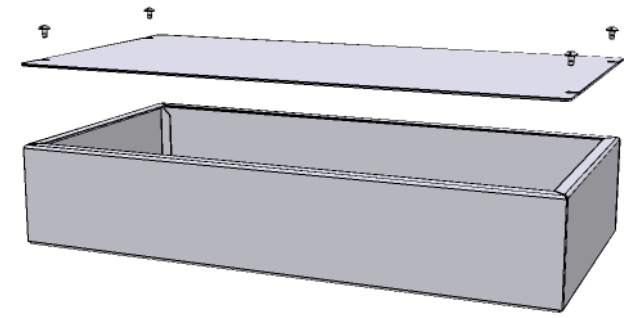

<b>MATERIAL - 0.051" UNPAINTED ALUMINUM - ALL PARTS SOLD SEPERATELY</b>
- CHASIS - 1444-28
- COVER - 1434-26
- 6 SCREWS (6-32 x 1/4 SHEET METAL SCREWS) - 1421J6

Contact Factory [mjm@hammondmfg.com](mailto:mjm@hammondmfg.com) for quotes  
 Enclosures can be Factory Modified ( Milling, Drilling, Printing etc. )  
 Solid models of this enclosure available in STEP or IGES.



**HAMMOND  
MANUFACTURING™**

**1444-28**  
[www.hammondmfg.com](http://www.hammondmfg.com)