

N-channel 950 V, 0.120 Ω typ., 38 A, MDmesh™ DK5 Power MOSFETs in TO-247 and TO-247 long leads packages

Datasheet - production data

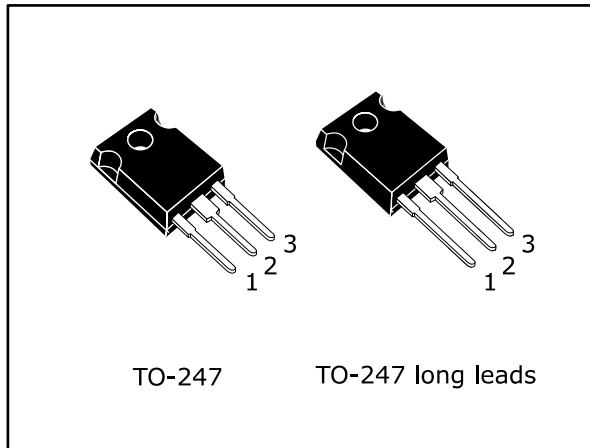
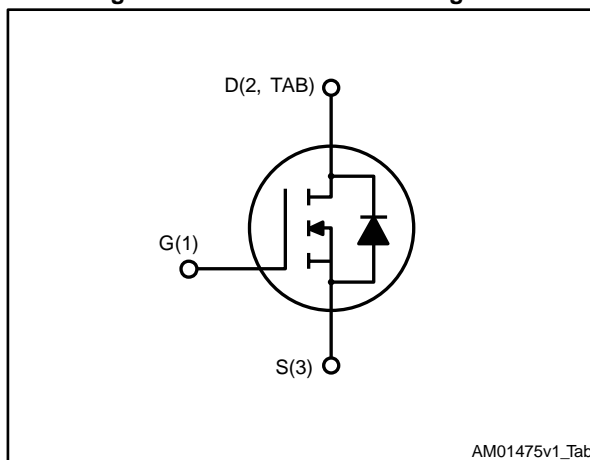

Figure 1: Internal schematic diagram



Features

| Order code | V _{DS} | R _{DS(on)} max. | I _D |
|--------------|-----------------|--------------------------|----------------|
| STW40N95DK5 | 950 V | 0.130 Ω | 38 A |
| STWA40N95DK5 | | | |

- Fast-recovery body diode
- Best R_{DS(on)} x area
- Low gate charge, input capacitance and resistance
- 100% avalanche tested
- Extremely high dv/dt ruggedness

Applications

- Switching applications

Description

These very high voltage N-channel Power MOSFETs are part of the MDmesh™ DK5 fast recovery diode series. The MDmesh™ DK5 combines very low recovery charge (Q_{rr}) and recovery time (t_{rr}) with an excellent improvement in R_{DS(on)} * area and one of the most effective switching behaviors, ideal for half bridge and full bridge converters.

Table 1: Device summary

| Order code | Marking | Package | Packing |
|--------------|----------|-------------------|---------|
| STW40N95DK5 | 40N95DK5 | TO-247 | Tube |
| STWA40N95DK5 | | TO-247 long leads | |

Contents

| | | |
|----------|---|-----------|
| 1 | Electrical ratings | 3 |
| 2 | Electrical characteristics | 4 |
| | 2.1 Electrical characteristics (curves)..... | 6 |
| 3 | Test circuits | 8 |
| 4 | Package information | 9 |
| | 4.1 TO-247 package information..... | 9 |
| | 4.2 TO-247 long leads package information | 11 |
| 5 | Revision history | 13 |

1 Electrical ratings

Table 2: Absolute maximum ratings

| Symbol | Parameter | Value | Unit |
|----------------|---|------------|------|
| V_{GS} | Gate-source voltage | 30 | V |
| I_D | Drain current (continuous) at $T_C = 25\text{ °C}$ | 38 | V |
| I_D | Drain current (continuous) at $T_C = 100\text{ °C}$ | 24 | A |
| $I_{DM}^{(1)}$ | Drain current (pulsed) | 152 | A |
| P_{TOT} | Total dissipation at $T_C = 25\text{ °C}$ | 450 | W |
| $dv/dt^{(2)}$ | Peak diode recovery voltage slope | 50 | V/ns |
| $dv/dt^{(3)}$ | MOSFET dv/dt ruggedness | 50 | V/ns |
| T_{stg} | Storage temperature range | -55 to 150 | °C |
| T_j | Operating junction temperature range | | |

Notes:

(1)Pulse width limited by safe operating area

(2) $I_{SD} \leq 19\text{ A}$, $di/dt \leq 400\text{ A}/\mu\text{s}$; $V_{DS\text{ peak}} \leq V_{(BR)DSS}$, $V_{DD} = 475\text{ V}$

(3) $V_{DS} \leq 760\text{ V}$

Table 3: Avalanche characteristics

| Symbol | Parameter | Value | Unit |
|----------------|-------------------------------------|-------|------|
| $R_{thj-case}$ | Thermal resistance junction-case | 0.28 | °C/W |
| $R_{thj-amb}$ | Thermal resistance junction-ambient | 50 | °C/W |

Table 4: Thermal data

| Symbol | Parameter | Value | Unit |
|----------|--|-------|------|
| I_{AR} | Max current during repetitive or single pulse avalanche | 13 | A |
| E_{AS} | Single pulse avalanche energy (starting $T_J = 25\text{ °C}$, $I_D = 13\text{ A}$, $V_{DD} = 50\text{ V}$) | 730 | mJ |

2 Electrical characteristics

(T_{CASE} = 25 °C unless otherwise specified)

Table 5: On/off states

| Symbol | Parameter | Test conditions | Min. | Typ. | Max. | Unit |
|----------------------|-----------------------------------|--|------|-------|-------|------|
| V _{(BR)DSS} | Drain-source breakdown voltage | I _D = 1 mA, V _{GS} = 0 V | 950 | | | V |
| I _{DSS} | Zero gate voltage drain current | V _{GS} = 0 V, V _{DS} = 950 V | | | 1 | μA |
| | | V _{GS} = 0 V, V _{DS} = 950 V, T _C = 125 °C ⁽¹⁾ | | | 100 | μA |
| I _{GSS} | Gate source leakage current | V _{DS} = 0 V, V _{GS} = ± 20 V | | | ±10 | μA |
| V _{GS(th)} | Gate threshold voltage | V _{DD} = V _{GS} , I _D = 100 μA | 3 | 4 | 5 | V |
| R _{DS(on)} | Static drain-source on-resistance | V _{GS} = 10 V, I _D = 19 A | | 0.120 | 0.130 | Ω |

Notes:

⁽¹⁾Defined by design, not subject to production test

Table 6: Dynamic

| Symbol | Parameter | Test conditions | Min. | Typ. | Max. | Unit |
|-----------------------------------|---------------------------------------|---|------|------|------|------|
| C _{iss} | Input capacitance | V _{DS} = 100 V, f = 1 MHz, V _{GS} = 0 V | - | 3480 | - | pF |
| C _{oss} | Output capacitance | | - | 235 | - | pF |
| C _{rss} | Reverse transfer capacitance | | - | 2.3 | - | pF |
| C _{o(tr)} ⁽¹⁾ | Equivalent capacitance time related | V _{GS} = 0 V, V _{DS} = 0 to 760 V | - | 371 | - | pF |
| C _{o(er)} ⁽²⁾ | Equivalent capacitance energy related | | - | 134 | - | pF |
| R _g | Intrinsic gate resistance | f = 1 MHz, I _D = 0 A | - | 2 | - | Ω |
| Q _g | Total gate charge | V _{DD} = 760 V, I _D = 38 A, V _{GS} = 10 V (see Figure 15: "Test circuit for gate charge behavior") | - | 100 | - | nC |
| Q _{gs} | Gate source charge | | - | 19.5 | - | nC |
| Q _{gd} | Gate drain charge | | - | 67.6 | - | nC |

Notes:

⁽¹⁾Time related is defined as a constant equivalent capacitance giving the same charging time as C_{oss} when V_{DS} increases from 0 to 80% V_{DSS}

⁽²⁾Energy related is defined as a constant equivalent capacitance giving the same stored energy as C_{oss} when V_{DS} increases from 0 to 80% V_{DSS}

Table 7: Switching times

| Symbol | Parameter | Test conditions | Min. | Typ. | Max. | Unit |
|--------------|---------------------|--|------|------|------|------|
| $t_{d(on)}$ | Turn-on delay time | $V_{DS} = 475 \text{ V}$, $I_D = 19 \text{ A}$, $R_G = 4.7 \Omega$, $V_{GS} = 10 \text{ V}$ (see Figure 14 : "Test circuit for resistive load switching times") | - | 30 | - | ns |
| t_r | Rise time | | - | 15 | - | ns |
| $t_{d(off)}$ | Turn-off delay time | | - | 82 | - | ns |
| t_f | Fall time | | - | 11 | - | ns |

Table 8: Source-drain diode

| Symbol | Parameter | Test conditions | Min. | Typ. | Max. | Unit |
|-----------------|-------------------------------|---|------|------|------|---------------|
| I_{SD} | Source-drain current | | - | | 38 | A |
| $I_{SDM}^{(1)}$ | Source-drain current (pulsed) | | - | | 152 | A |
| $V_{SD}^{(2)}$ | Forward on voltage | $I_{SD} = 38 \text{ A}$, $V_{GS} = 0 \text{ V}$ | - | | 1.5 | V |
| t_{rr} | Reverse recovery time | $I_{SD} = 19 \text{ A}$, $di/dt = 100 \text{ A}/\mu\text{s}$, $V_{DD} = 60 \text{ V}$ (see Figure 16 : "Test circuit for inductive load switching and diode recovery times") | - | 170 | | ns |
| Q_{rr} | Reverse recovery charge | | - | 1.4 | | μC |
| I_{RRM} | Reverse recovery current | | - | 15 | | A |
| t_{rr} | Reverse recovery time | $I_{SD} = 19 \text{ A}$, $di/dt = 100 \text{ A}/\mu\text{s}$, $V_{DD} = 60 \text{ V}$, $T_j = 150 \text{ }^\circ\text{C}$ (see Figure 16 : "Test circuit for inductive load switching and diode recovery times") | - | 340 | | ns |
| Q_{rr} | Reverse recovery charge | | - | 5 | | μC |
| I_{RRM} | Reverse recovery current | | - | 30 | | A |

Notes:

(1) Pulse width limited by safe operating area.

(2) Pulsed: pulse duration = 300 μs , duty cycle 1.5%.

2.1 Electrical characteristics (curves)

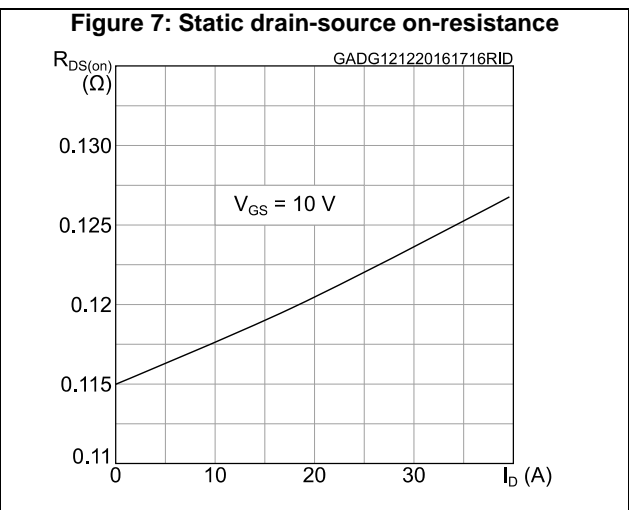
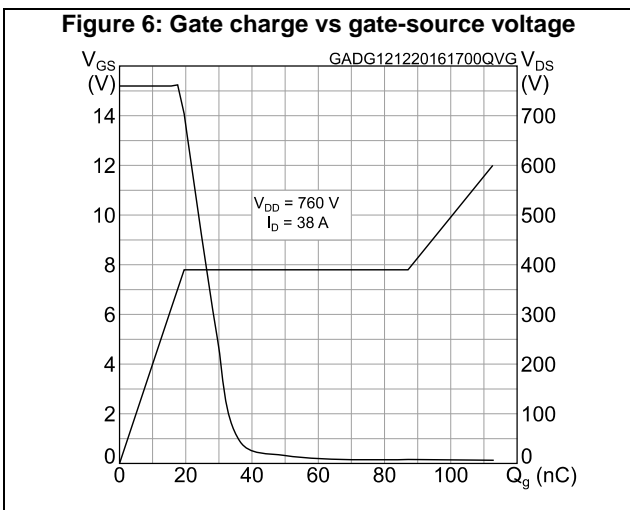
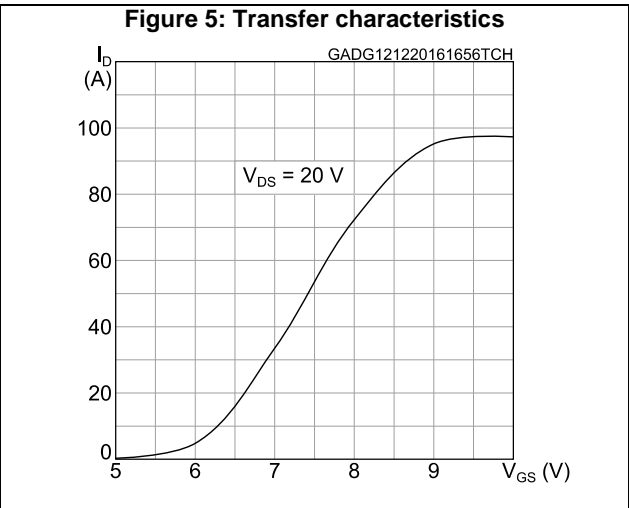
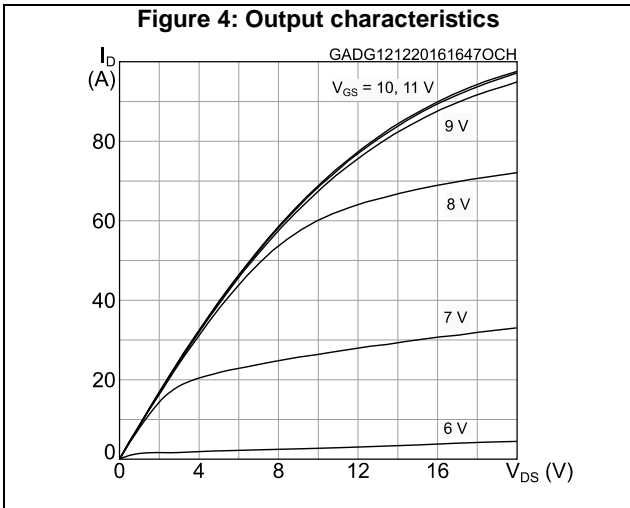
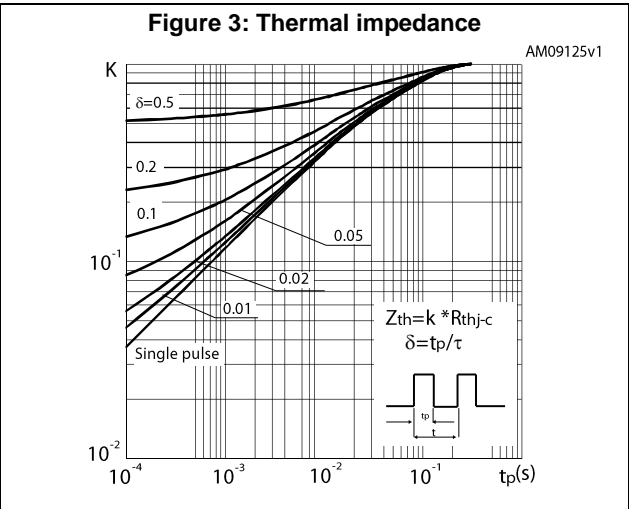
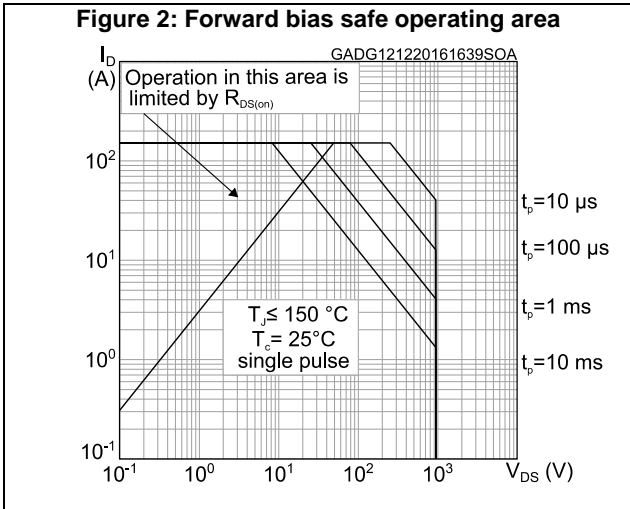

Figure 8: Capacitance variations

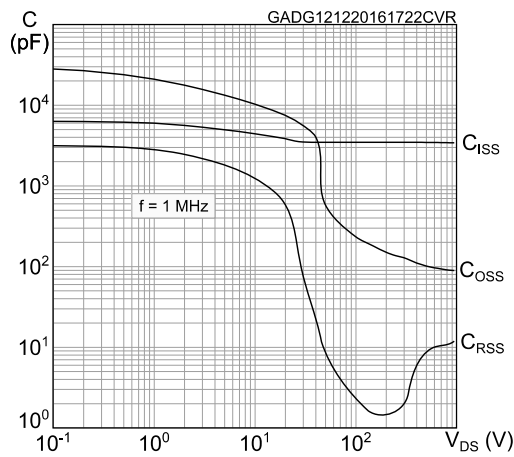

Figure 9: Normalized gate threshold voltage vs temperature

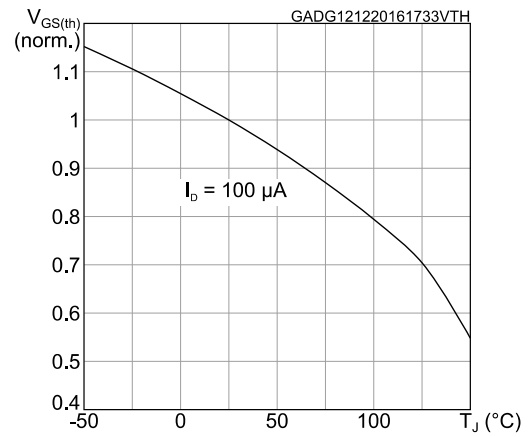

Figure 10: Normalized on-resistance vs temperature

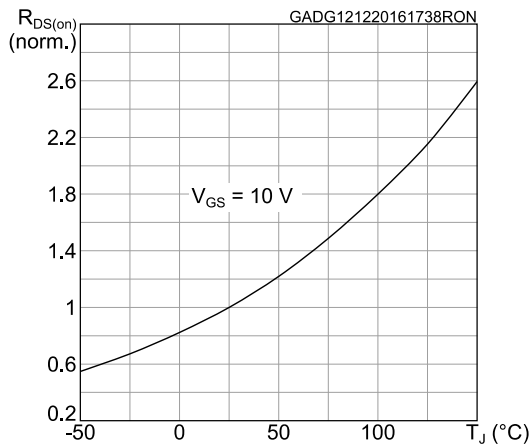

Figure 11: Normalized V(BR)DSS vs temperature

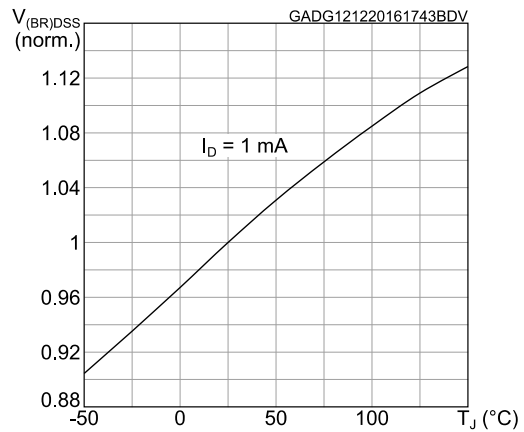

Figure 12: Source-drain diode forward characteristics

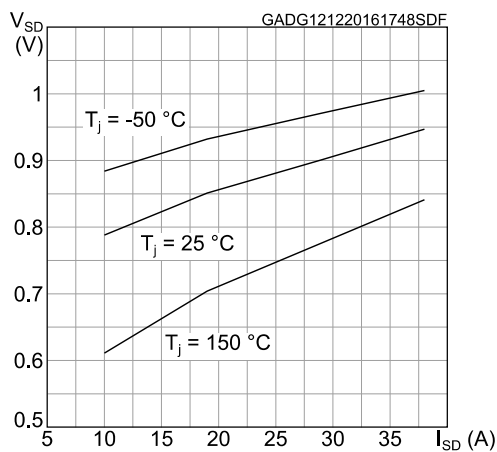
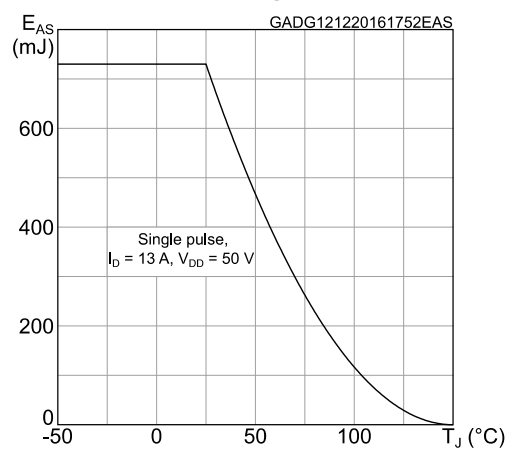

Figure 13: Maximum avalanche energy vs starting T_J



3 Test circuits

Figure 14: Test circuit for resistive load switching times



AM01468v1

Figure 15: Test circuit for gate charge behavior



AM01469v1

Figure 16: Test circuit for inductive load switching and diode recovery times

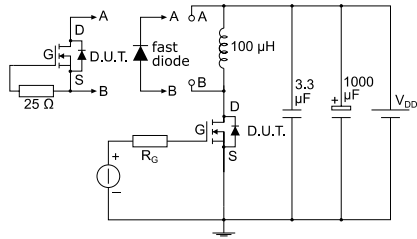

AM01470v1

Figure 17: Unclamped inductive load test circuit

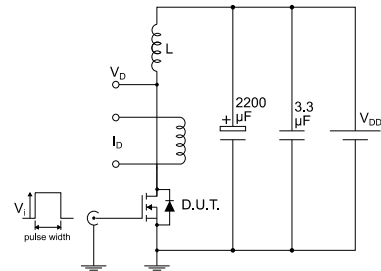

AM01471v1

Figure 18: Unclamped inductive waveform

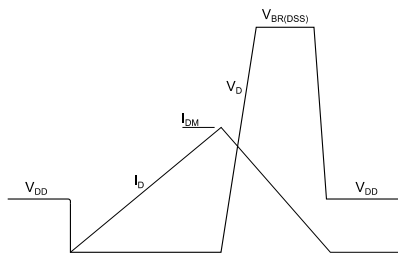

AM01472v1

Figure 19: Switching time waveform

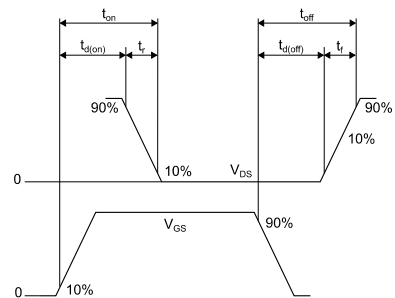

AM01473v1

4 Package information

In order to meet environmental requirements, ST offers these devices in different grades of ECOPACK® packages, depending on their level of environmental compliance. ECOPACK® specifications, grade definitions and product status are available at: www.st.com. ECOPACK® is an ST trademark.

4.1 TO-247 package information

Figure 20: TO-247 package outline

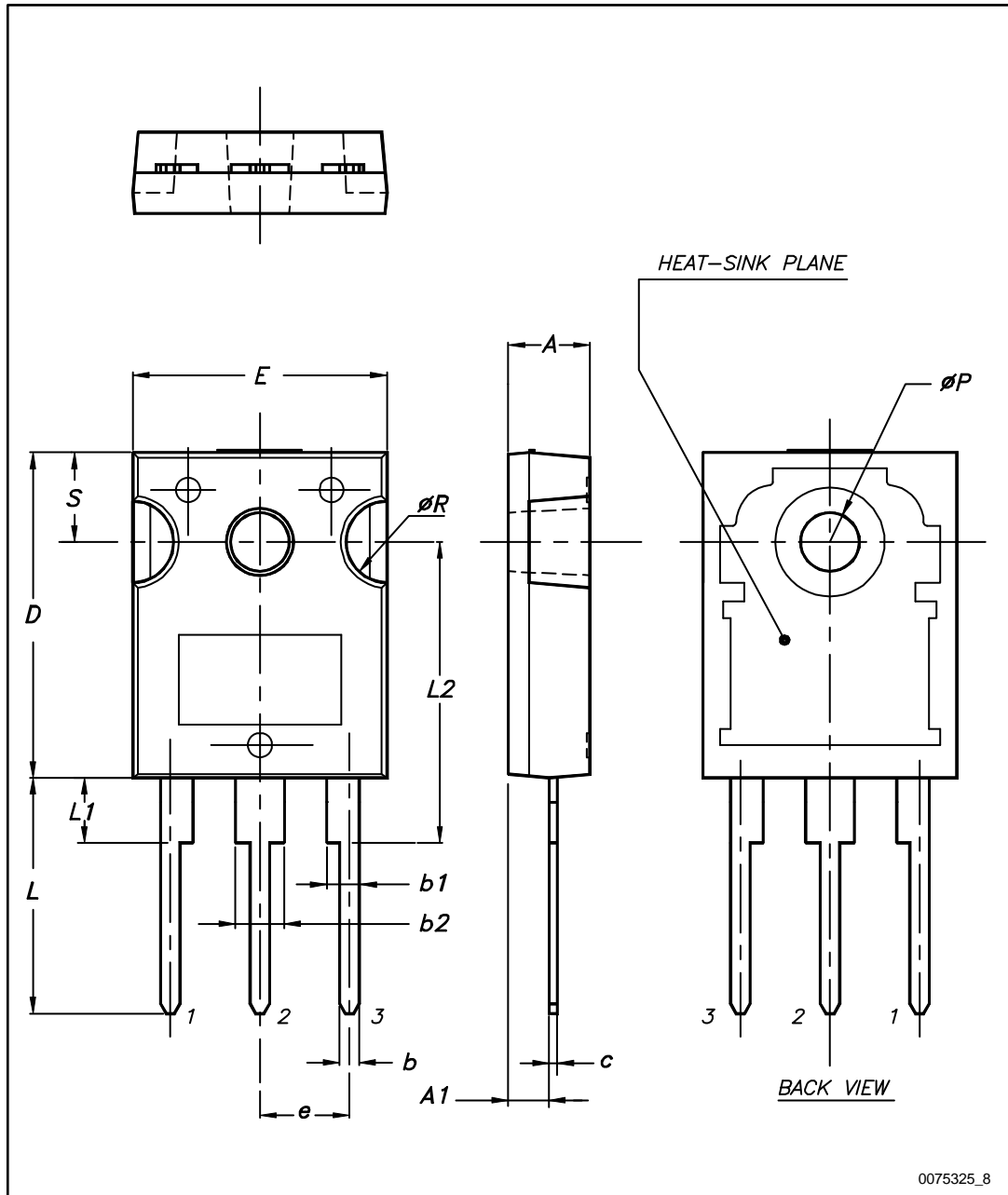

0075325_8

Table 9: TO-247 package mechanical data

| Dim. | mm | | |
|------|-------|-------|-------|
| | Min. | Typ. | Max. |
| A | 4.85 | | 5.15 |
| A1 | 2.20 | | 2.60 |
| b | 1.0 | | 1.40 |
| b1 | 2.0 | | 2.40 |
| b2 | 3.0 | | 3.40 |
| c | 0.40 | | 0.80 |
| D | 19.85 | | 20.15 |
| E | 15.45 | | 15.75 |
| e | 5.30 | 5.45 | 5.60 |
| L | 14.20 | | 14.80 |
| L1 | 3.70 | | 4.30 |
| L2 | | 18.50 | |
| ØP | 3.55 | | 3.65 |
| ØR | 4.50 | | 5.50 |
| S | 5.30 | 5.50 | 5.70 |

4.2 TO-247 long leads package information

Figure 21: TO-247 long lead package outline

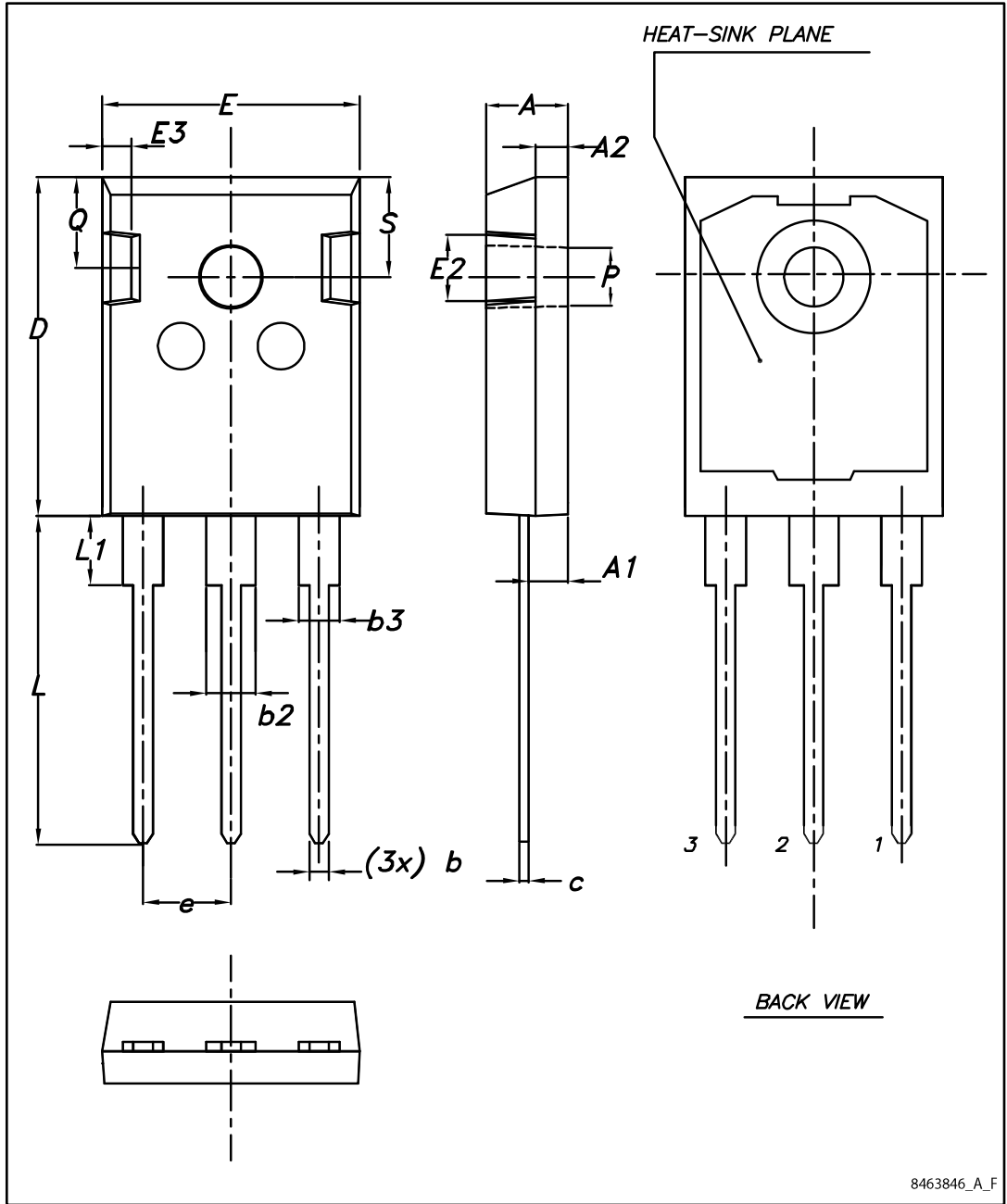

Table 10: TO-247 long lead package mechanical data

| Dim. | mm | | |
|------|-------|-------|-------|
| | Min. | Typ. | Max. |
| A | 4.90 | 5.00 | 5.10 |
| A1 | 2.31 | 2.41 | 2.51 |
| A2 | 1.90 | 2.00 | 2.10 |
| b | 1.16 | | 1.26 |
| b2 | | | 3.25 |
| b3 | | | 2.25 |
| c | 0.59 | | 0.66 |
| D | 20.90 | 21.00 | 21.10 |
| E | 15.70 | 15.80 | 15.90 |
| E2 | 4.90 | 5.00 | 5.10 |
| E3 | 2.40 | 2.50 | 2.60 |
| e | 5.34 | 5.44 | 5.54 |
| L | 19.80 | 19.92 | 20.10 |
| L1 | | | 4.30 |
| P | 3.50 | 3.60 | 3.70 |
| Q | 5.60 | | 6.00 |
| S | 6.05 | 6.15 | 6.25 |

5 Revision history

Table 11: Document revision history

| Date | Revision | Changes |
|-------------|----------|--|
| 19-Sep-2013 | 1 | First release. |
| 13-Nov-2015 | 2 | Updated title, features and description in cover page. Updated Section 10 : "Electrical characteristics" and Section 12.1:"TO-247 package information" Minor text changes. |
| 12-Apr-2016 | 3 | Updated title,silhouette and description in cover page. Updated <i>Table 2: "Absolute maximum ratings"</i> . Updated <i>Section 10: "Electrical characteristics"</i> . Added <i>Figure 21: "TO-247 long lead package outline"</i> . Minor text changes |
| 15-Dec-2016 | 4 | Datasheet status promoted from preliminary to production data. Updated document title on cover page. Updated <i>Table 2: "Absolute maximum ratings"</i> , <i>Table 4: "Thermal data"</i> , <i>Table 5: "On/off states"</i> , <i>Table 6: "Dynamic"</i> and <i>Table 8: "Source-drain diode"</i> . Added <i>Section 2.1: "Electrical characteristics (curves)"</i> . Minor text changes |

IMPORTANT NOTICE – PLEASE READ CAREFULLY

STMicroelectronics NV and its subsidiaries ("ST") reserve the right to make changes, corrections, enhancements, modifications, and improvements to ST products and/or to this document at any time without notice. Purchasers should obtain the latest relevant information on ST products before placing orders. ST products are sold pursuant to ST's terms and conditions of sale in place at the time of order acknowledgement.

Purchasers are solely responsible for the choice, selection, and use of ST products and ST assumes no liability for application assistance or the design of Purchasers' products.

No license, express or implied, to any intellectual property right is granted by ST herein.

Resale of ST products with provisions different from the information set forth herein shall void any warranty granted by ST for such product.

ST and the ST logo are trademarks of ST. All other product or service names are the property of their respective owners.

Information in this document supersedes and replaces information previously supplied in any prior versions of this document.

© 2016 STMicroelectronics – All rights reserved