

# LTC4282

## Low Stress Staged Start 200A Hot Swap Controller

### DESCRIPTION

Demonstration circuit 2442A features the [LTC<sup>®</sup>4282](#) high current Hot Swap controller. The LTC4282 is well suited to high power applications because the precise monitoring capability and accurate current limiting reduces the extremes in which both loads and power supplies must safely operate. Nonvolatile configuration allows for flexibility in the autonomous generation of alerts and response to faults. The LTC4282 provides a rich set of features to support Hot Swap applications including:

- 12- to 16-Bit ADC Monitors Current, Voltage, Power and Energy
- Controls Two Sets of Parallel MOSFETs for High Current Applications

- I<sup>2</sup>C/SMBus Interface
- Nonvolatile Configuration and Logging Functions
- Generates Alerts on ADC Measurements Outside Limits
- Software Adjustable Current Limit with Foldback
- Three General Purpose Input/Outputs

Available in a 32-pin 5mm × 5mm QFN package, the LTC4282 is showcased on DC2442A configured in a “Low Stress Staged Start” configuration for a 12V/200A application.

**Design files for this circuit board are available at <http://www.linear.com/demo/DC2442A>**

LT, LT, LTC, LTM, Linear Technology, the Linear logo and LTpowerPlay are registered trademarks of Linear Technology Corporation. All other trademarks are the property of their respective owners.

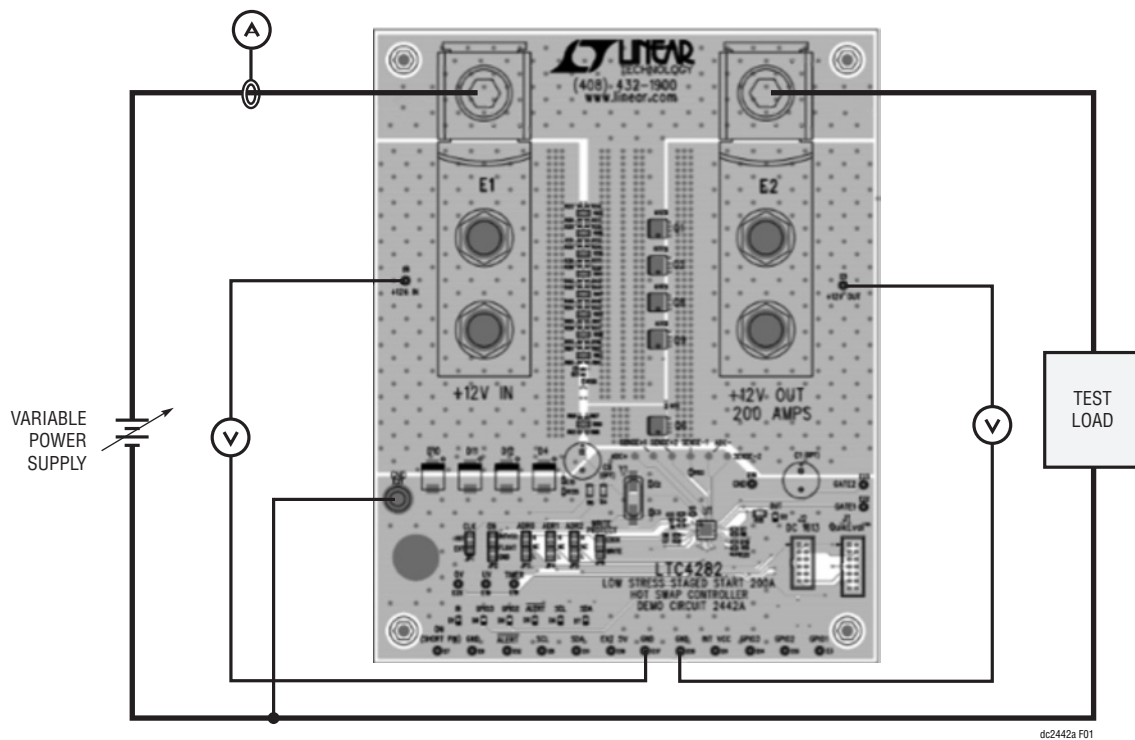

Figure 1. Basic Test Setup

# DEMO MANUAL DC2442A

## PERFORMANCE SUMMARY Specifications are at $T_A = 25^\circ\text{C}$

PARAMETER	CONDITIONS	VALUE
Input Supply Voltage Range		2.9V to 33V
Nominal Operating Voltage		12.0V
Overvoltage Lockout	Nominal	15.0V
Undervoltage Lockout	Nominal	11.1V
Output Current Limit	Nominal	207A
Maximum Load Capacitance	Nominal	20,000 $\mu\text{F}$
Timer Expiration Period	Nominal	1.4ms

## QUICK START PROCEDURE

Table 1. Power Input and Output Connections

NOMENCLATURE	CONNECTOR	DESCRIPTION
+12V <sub>IN</sub>	E1	+12V Power In
+12V <sub>OUT</sub> 200A	E2	+12V Power Out
GND	E21 (Banana)	Power Supply Common

Table 2. Test Points, Turrets

NOMENCLATURE	TURRET	DESCRIPTION
GPI01	E3	GPI01 Pin I/O
INTV <sub>CC</sub>	E4	Internal V <sub>CC</sub>
+12V <sub>OUT</sub>	E5	+12V <sub>OUT</sub> Monitor
+12V <sub>IN</sub>	E6	+12V <sub>IN</sub> Monitor
ON (SHORT PIN)	E7	ON Pin Monitor/Input
SCL	E8	I <sup>2</sup> C Serial Clock Input
GND	E9, E10, E15, E17	Ground
SDA	E11	I <sup>2</sup> C Serial Data Input/Output
ALERT	E12	ALERT Pin
GPI02	E13	GPI02 Pin I/O
GPI03	E14	GPI03 I/O
EXT 5V	E16	
TIMER	E18	TIMER Pin
UV	E19	UV Pin
OV	E20	OV Pin
GATE2	E23	GATE 2 Pin
GATE1	E22	GATE 1 Pin

## QUICK START PROCEDURE

Table 3. LED Indicators

NOMENCLATURE	LED	DESCRIPTION
IN	D1 (Green)	Input Power Indicator
OUT	D2 (Green)	Output Power Indicator
ALERT	D5 (Red)	ALERT Pin Logic Low
SCL	D6 (Green)	Serial Clock Active
SDA	D7 (Green)	Serial Data Active
GPIO3	D8 (Green)	GPIO3 Logic Low
GPIO2	D9 (Green)	GPIO2 Logic Low

Table 4. Jumpers

NOMENCLATURE	JUMPER	DESCRIPTION
CLK, INT, EXT	JP1	Internal/External Clock Select
ON, INTV <sub>CC</sub> , FLOAT, GND	JP2	ON Input Select, V <sub>CC</sub> , Float (External), GND
ADRO, H, NC, L	JP3	Address Pin ADRO Select
ADR1, H, NC, L	JP4	Address Pin ADR1 Select
ADR2, H, NC, L	JP5	Address Pin ADR2 Select
WRITE PROTECT, LOCK, WRITE	JP6	Write Protect for EEPROM

Table 5. Connectors

NOMENCLATURE	CONNECTOR	DESCRIPTION
DC590	J1	Connection for DC590
DC1613	J2	Connection for DC1613

## QUICK START PROCEDURE

### Operating Principles

The LTC4282 is a low voltage, high current Hot Swap controller that has a 2.9V to 33V operating range and a 45V absolute maximum operating voltage for the  $V_{DD}$  pin. The DC2442A is populated for +12V operation and is configured for a “Low Stress Staged Start” configuration. For details on this configuration refer to the “Low Stress Staged Start Configuration” section.

The DC2442A is populated with a total of eight  $0.9\text{m}\Omega$  MOSFETs and one  $11\text{m}\Omega$  MOSFET in a LPAK package. A total of sixteen  $1\text{m}\Omega$  sense resistors are used, providing typically 207A of load current. The current limit and circuit breaker thresholds can be adjusted by changing the sense resistors R25, R30, R35, R41, R47, R53, R58, R63, R80, R85, R90, R95, R100, R105, R110 and R115 and/or the value of  $\Delta V_{\text{SENSE}}$  via registers in the LTC4282.

On the DC2442A, the LTC4282 is preprogrammed for a  $\Delta V_{\text{SENSE}}$  of 12.5mV to reduce power dissipation in the sense resistors at such high currents; it has not been tested for  $\Delta V_{\text{SENSE}}$  greater than 12.5mV. It is strongly advised not to adjust this threshold on the DC2442A without careful consideration of the power dissipation in the sense resistors.

### Low Stress Staged Start Configuration

In the Low Stress Staged Start configuration, the dual gates are taken advantage of where one channel works as a trickle charging channel, responsible for trickle charging the output during turn on and the other channel is the bypass channel which turns on only when the power to the output is good (within 0.7V of the input). The power good signal is used to hold the bypass channel gate off, by keeping it in artificial current limit, until the trickle channel has powered up the load. The start-up trickle MOSFET Q1 is a compact, inexpensive device with small SOA and is configured for a low current limit with a GATE capacitor to limit inrush current. When the load is fully charged and the start-up MOSFET is fully enhanced, the power good signal is asserted, releasing the bypass channel’s sense pin and enabling it. The bypass side has a high current limit to deliver the full load current, and uses low  $R_{\text{DS(ON)}}$ , low SOA switching regulator class MOSFETs. The TIMER capacitor is selected for a short time within the SOA of the bypass MOSFETs.

This architecture minimizes the cost of MOSFETs to achieve a given load current and  $R_{\text{DS(ON)}}$ . However, with the short current limit time, it has limited ability to ride through a load surge in current limit or input voltage steps, and due to the low start-up current cannot start up a resistive load such as a heating element or incandescent lamp.

## QUICK START PROCEDURE (WITHOUT SOFTWARE)

DC2442A is easy to set up to evaluate the performance of the LTC4282. Refer to Figure 1 for proper measurement equipment setup and follow the procedure below.

**WARNING:** *The DC2442A is capable of operation in excess of 200A. At this current and power level, there is a danger of serious personal injury and equipment damage if proper techniques are not used. All cabling between the power supply and the load should be capable of handling the current levels used.*

Additionally, the high currents and fast transients can cause unexpected voltage drops in cables connecting the test equipment to the DC2442A due to parasitic resistance and inductance. The cable drops may cause sneak paths for the current via various cables and scope probes causing unexplained ringing, distorted oscilloscope waveforms, voltage and current spikes, and signals appearing to be below ground.

A common sneak path for current is the third wire ground used on power cords of test equipment in use. Using ground lifting connectors at the wall outlet won't necessarily alleviate these effects since most equipment has line-bypassing capacitors between the mains voltage and local chassis ground. Isolating test equipment using line isolation transformers with low primary to secondary capacitance is recommended.

Another method to remove these artifacts is to use differential scope probes to probe connections between the signal to be observed and a local ground referenced to the point being measured.

Also be careful to not allow an open ground from the power supply or load to cause return current through the grounds of the various devices connected to the demo board. This can cause damage to the equipment as well as cause a fire hazard.

The DC2442A is setup to operate in a 12V system at current levels up to 200A. At 200A, the bypass channels MOSFETs are dissipating only 500mW each. No additional airflow is

needed for continuous operation, the total temperature rise of the board averaging around 70°C with no airflow. If the MOSFET count is reduced, ensure that there is sufficient airflow to manage thermal dissipation.

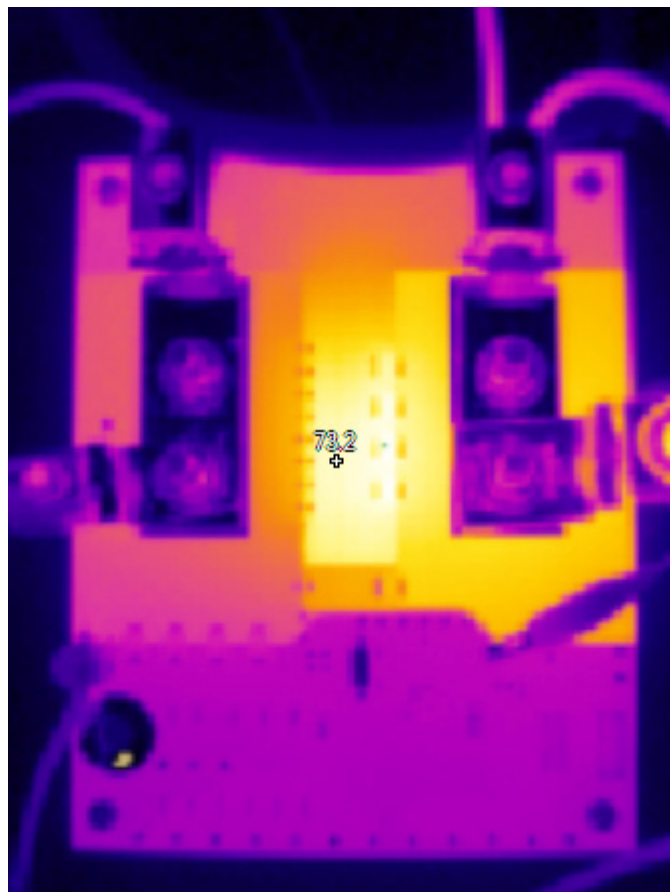

**Figure 2. Demo Board Temperature at 73°C After 10 Minutes of Continuous Operation at 200A with No Airflow**

### Jumper Positions

JUMPER	NAME	POSITION
JP1	CLK	EXT
JP2	ON	INTV <sub>CC</sub>
JP3	ADR0	NC
JP4	ADR1	NC
JP5	ADR2	NC
JP6	WRITE PROTECT	LOCK

## QUICK START PROCEDURE (WITHOUT SOFTWARE)

### Powering Up

Connect power supply capable of 220A at 0V to 20V to the 12V input as shown in Figure 1. Verify that the cabling, shown in extra bold lines, is capable of carrying 200A safely. The GND connection does not handle high current so no high current cabling is required.

Generally, an electronic load will be used. If this is true, use it in the constant resistance mode. Use in constant current will prevent start-up because of current foldback in the LTC4282. To minimize power dissipation in the MOSFETs, current is initially limited to approximately 30% of the full current limit that is available when the output voltage is above 10V. If a constant current load is used and set to 200A, the LTC4282 will not start-up and a current fault will be reported.

### UV/OV Thresholds

With no load on the output, slowly increase the voltage on the input to the board. Observe the input voltage when LED D2 (OUT) illuminates. This voltage should be between 10.7V and 11.4V. Continue increasing voltage until D2 is extinguished. This should occur between 14.4V and 15.3V.

### Output Voltage Slew Rate

With no load connected, observe the output voltage between turret +12V<sub>OUT</sub> (E5), and GND. Apply 12V to the +12V<sub>IN</sub> connector. The output voltage should slew from 0V to 12V in 10ms to 25ms.

### Output Current Limit

Turn off power supply and connect electronic load to the DC2442 as shown in Figure 1. Disable electronic load. Adjust power supply to 12V and verify its current level is set to > 200A.

Slowly increase conductance of the electronic load while monitoring current. As the load increases to around 200A, the output voltage and current will fall to zero. Note the current where this occurs. This should be between 200A to 210A.

### Ability to Charge Output Capacitor

Turn off power supply and disconnect electronic load. Replace load with a 20,000 $\mu$ F capacitor rated at 15V or greater. Turn on power supply and observe that the output voltage rises to 12V indicating the DC2442 has connected to the load and successfully charged the output capacitance. This should happen within 400ms to 500ms.

---

## SOFTWARE CONTROL WITH LTpowerPlay

LTpowerPlay<sup>®</sup> is a convenient PC software GUI that gives complete access to the registers of the LTC4282 and many other Linear Technology Power System Management parts. Use it in off-line mode to build a system configuration file even with no hardware plugged-in, and use it with hardware connected to configure and debug your application. LTpowerPlay communicates using the I<sup>2</sup>C bus in the demo system (covered in this manual), or in your real-world product environment. It provides unprecedented control over the Linear Technology chips on the I<sup>2</sup>C bus. Use it during board bring-up to tune and optimize the power system parameters. Use it during system debug to view critical system information and troubleshoot board design or manufacturing issues. LTpowerPlay includes extensive

help and documentation under the Help menu. Online help includes quick-start videos and tutorials, and detailed technical documentation from the Linear Technology website. Getting started with LTpowerPlay is easy. Simply download and install the PC software from here:

<http://www.linear.com/LTpowerPlay>

**WARNING:** The LTC4282 comes preprogrammed in the Low Stress Staged Start configuration with specific settings, which support a 200A application. Changing the LTC4282's programming on the DC2442 is strongly discouraged to ensure safety and proper operation of the board. Exercise caution if changing register settings and refer to Table 7 for key register settings, which should remain untouched.

## SOFTWARE CONTROL WITH LTpowerPlay

Table 7. Critical Register Values for Default Demo Board Design

REGISTER ADDRESS	NAME	VALUE	COMMENT
0x06	FET_BAD_FAULT_TIMEOUT	0	Disable FET bad timeout to ensure startup into 20,000 $\mu$ F. Turn on takes around 400ms to 500ms while max FET_BAD_TIMEOUT is 255ms.
0x07	GPIO_CONFIG[5-4]	00	Power good must be enabled to ensure BYPASS channel only turns on when power is good. This setting is essential for Low Stress Staged Start configuration
0x11	ILIM_ADJUST[7-5]	00	Current limit has been adjusted to the lowest value to minimize power dissipation in the sense resistors. Increasing this will change the current limit as well as increase the power dissipation in the MOSFETs.

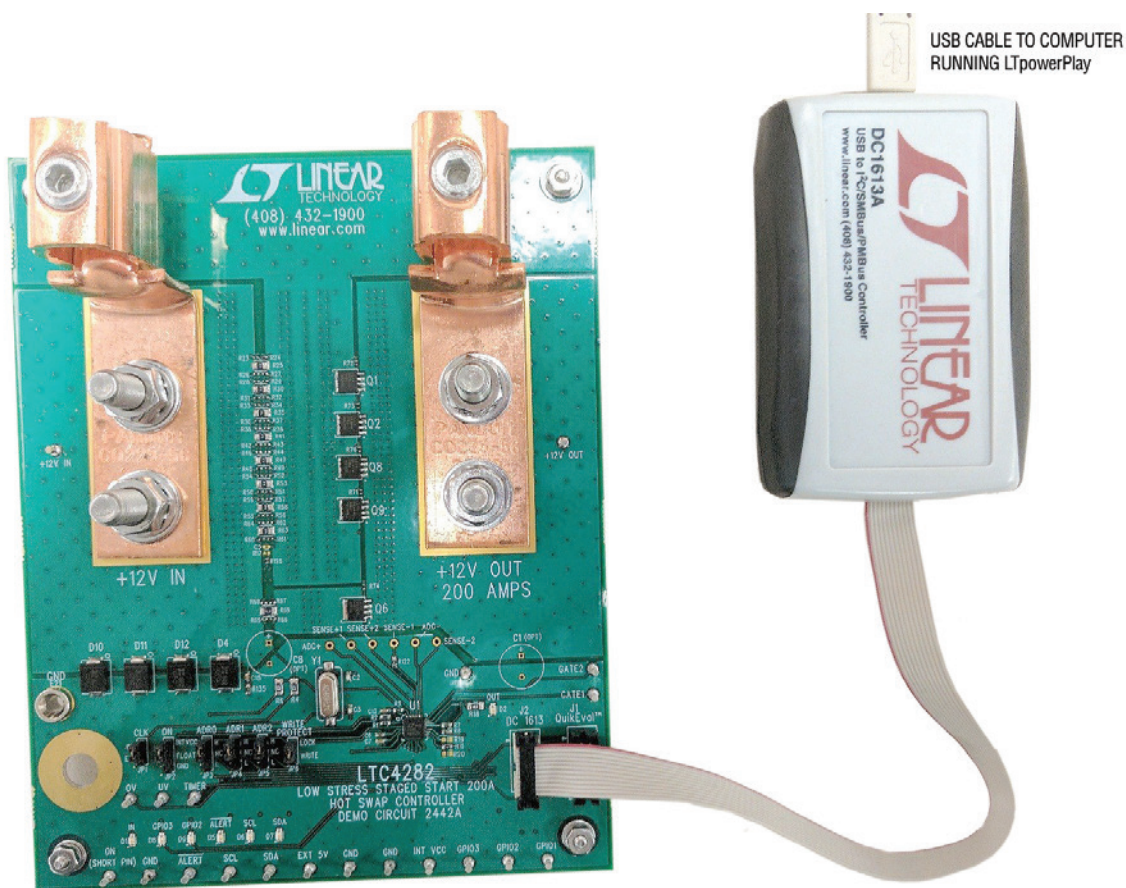

Figure 3. DC2442A Demo Board Connected to DC1613 I<sup>2</sup>C-to-USB Converter

# DEMO MANUAL DC2442A

## SOFTWARE CONTROL WITH LTpowerPlay

The DC1613 USB-to-I<sup>2</sup>C adapter interfaces the PC running LTpowerPlay to the DC2442A board. Connect the DC1613 adapter to the PC through a USB cable, and connect the DC2442A board through the ribbon cable to connector J2 (Figure 3).

Launch the LTpowerPlay GUI on the PC. The software identifies the DC1613 controller, then the DC2442A board, and begins communicating through the I<sup>2</sup>C bus with the LTC4282. Once this communication has been established, the GUI displays its main window (Figure 4).

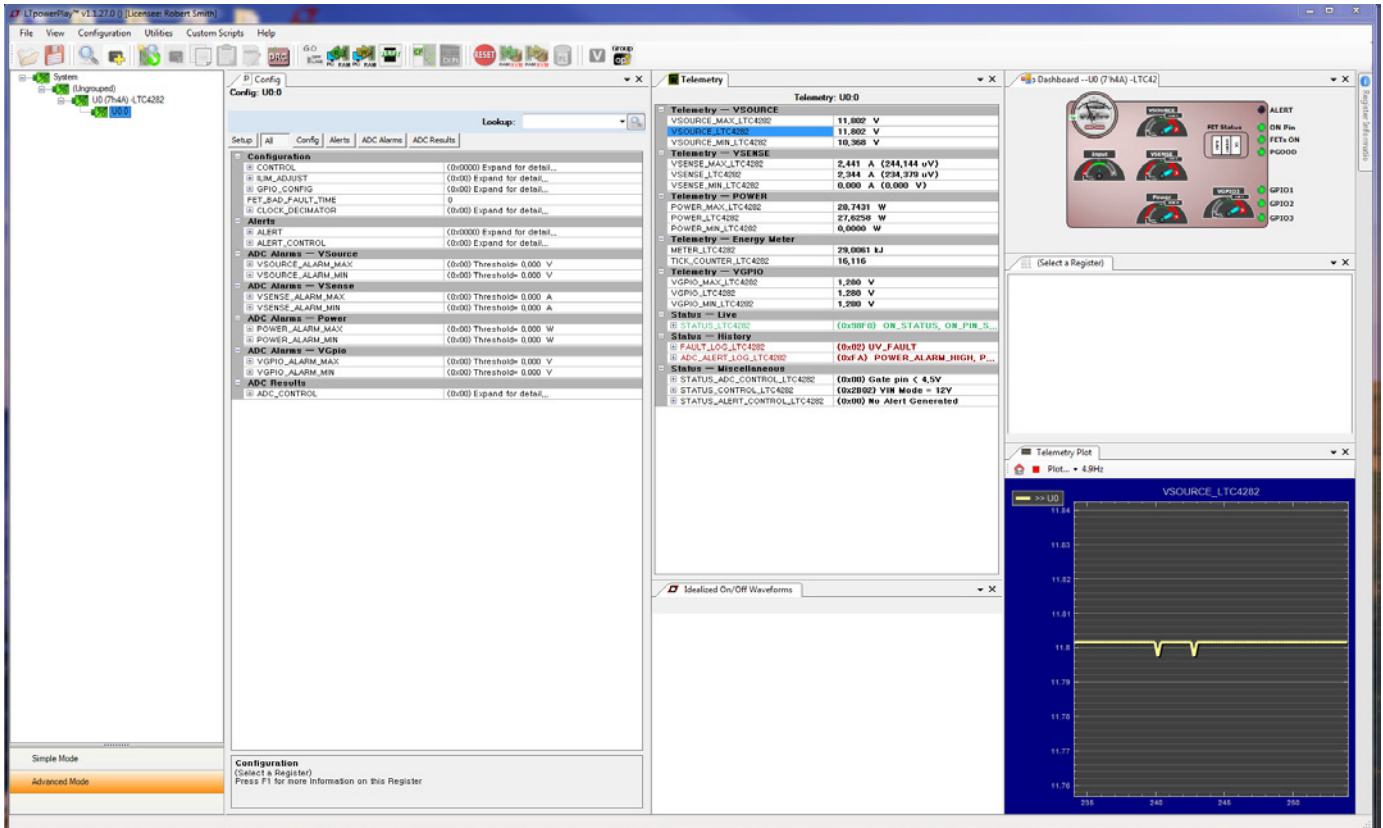

Figure 4. LTpowerPlay GUI Window



## SOFTWARE CONTROL WITH LTpowerPlay

The LTpowerPlay GUI divides information into separate panes in the window. On the left is the System Tree pane, displaying a list of all Linear Technology devices identified on the I<sup>2</sup>C bus. For a single LTC4282 device, the tree is small, but if other supported devices are present on the I<sup>2</sup>C bus, LTpowerPlay will add them. Click on a device in this list to selectively access it. Information in other panes pertains to the selected device.

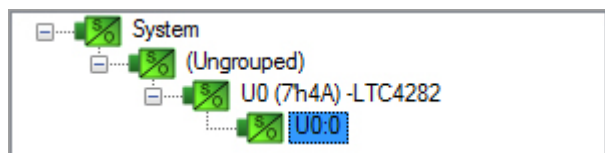

Figure 5. LTpowerPlay System Tree

To the right of the system tree is the Configuration Register pane displaying all of the configuration registers available on the selected device. This view shows all of the writable user-configurable RAM registers, and the GUI offers clickable buttons and fields to edit the information in these registers.

**Note:** Ensure that you set the resistor value of 62.5μΩ in the Setup tab before viewing register data to get correct current readout.

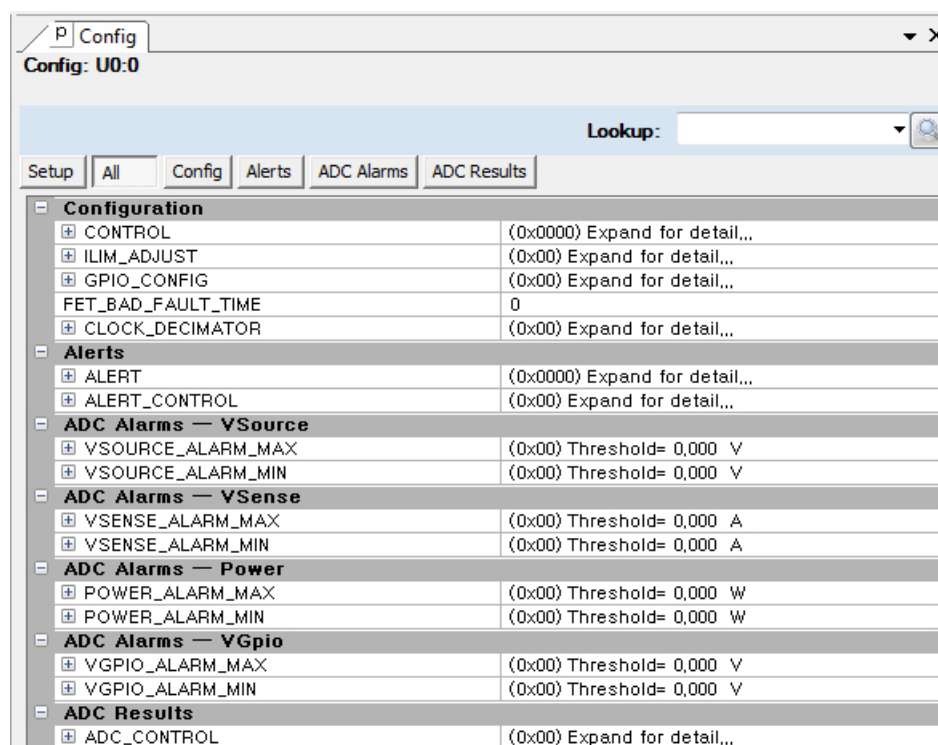

Figure 6. LTpowerPlay Configuration Registers

## SOFTWARE CONTROL WITH LTpowerPlay

Update registers contents by clicking or typing to change the desired registers, then selecting the “PC to RAM” button in the top toolbar. LTpowerPlay writes changes to the updated registers.



**Figure 7. PC to RAM Button Transfers Data Programmed from the GUI to the LTC4282 Volatile Registers**

Note that programming the registers in the LTC4282 should generally be done while the part is in the sequenced-down state—with the pass transistor turned off. Most of the registers have immediate control over their respective chip functions, and changing them while the part is sequenced-up will have unpredictable and adverse effects. It is recommended to sequence-down before updating configuration register settings, LTpowerPlay implements limits to writing some registers, based upon the device state, and will pop-up warnings when necessary.

Right of center in LTpowerPlay is the Telemetry pane, displaying read-only information contained in the status registers of the selected part. The GUI periodically polls the I<sup>2</sup>C bus and updates the Telemetry contents in real time, along with a user-friendly interpretation of the bits.

Telemetry: U0:0	
<b>Telemetry — VSOURCE</b>	
VSOURCE_MAX_LTC4282	11,802 V
VSOURCE_LTC4282	11,798 V
VSOURCE_MIN_LTC4282	10,368 V
<b>Telemetry — VSENSE</b>	
VSENSE_MAX_LTC4282	2,441 A (244,144 $\mu$ V)
VSENSE_LTC4282	2,344 A (234,379 $\mu$ V)
VSENSE_MIN_LTC4282	0,000 A (0,000 V)
<b>Telemetry — POWER</b>	
POWER_MAX_LTC4282	28,7431 W
POWER_LTC4282	27,6258 W
POWER_MIN_LTC4282	0,0000 W
<b>Telemetry — Energy Meter</b>	
METER_LTC4282	122,9659 kJ
TICK_COUNTER_LTC4282	68,243
<b>Telemetry — VGPI0</b>	
VGPI0_MAX_LTC4282	1,280 V
VGPI0_LTC4282	1,280 V
VGPI0_MIN_LTC4282	1,280 V
<b>Status — Live</b>	
STATUS_LTC4282	(0x98F0) ON_STATUS, ON_PIN_S...
<b>Status — History</b>	
FAULT_LOG_LTC4282	(0x02) UV_FAULT
ADC_ALERT_LOG_LTC4282	(0xFA) POWER_ALARM_HIGH, P...
<b>Status — Miscellaneous</b>	
STATUS_ADC_CONTROL_LTC4282	(0x00) Gate pin < 4.5V
STATUS_CONTROL_LTC4282	(0x2B02) VIN Mode = 12V
STATUS_ALERT_CONTROL_LTC4282	(0x00) No Alert Generated

**Figure 8. LTpowerPlay Telemetry**

In the upper right corner of LTpowerPlay is the Chip Dashboard pane, displaying a graphical representation of the part status in a friendly, easy-to-understand format. The meter in the upper left of the panel displays the static input energy to the card in watts. The small dials in the center of the Input Energy Meter display the energy used in kJoules. The V<sub>SOURCE</sub> meter displays the voltage at the SOURCE pin of the LTC4282, which is the same as V<sub>OUT</sub>. The INPUT meter displays the voltage input at the V<sub>DD</sub> pin of the LTC4282. V<sub>SENSE</sub> indicates the input current derived by dividing the voltage measured across the sense resistor divided by the value of the sense resistor. The Power Meter displays the SOURCE voltage multiplied by the current sense voltage and scaled to indicate the power in watts. V<sub>GPI03</sub> displays the voltage at GPI03 when it is configured as an analog input. The FET status annunciators show the status of the pass MOSFETs as described in the FET-BAD Fault section of the data sheets. GPI01, GPI02, and GPI03 show the status of the general purpose input/output pins.

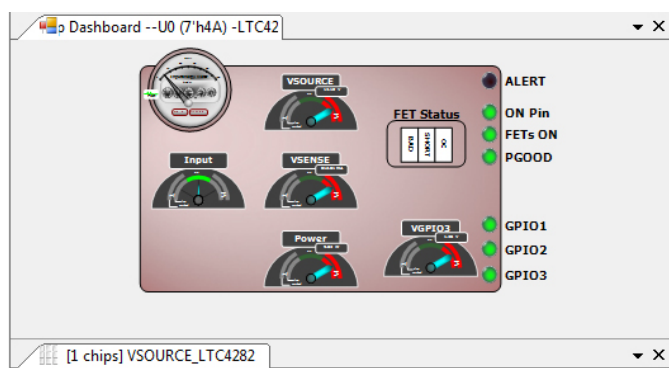

**Figure 9. LTpowerPlay Dashboard**

## SOFTWARE CONTROL WITH LTpowerPlay

On the lower right of the GUI window is the Telemetry Plot pane. By selecting various measurement functions in the Telemetry pane, a graphic display of that function vs time is displayed. This gives an instant indication how that function varies with time.

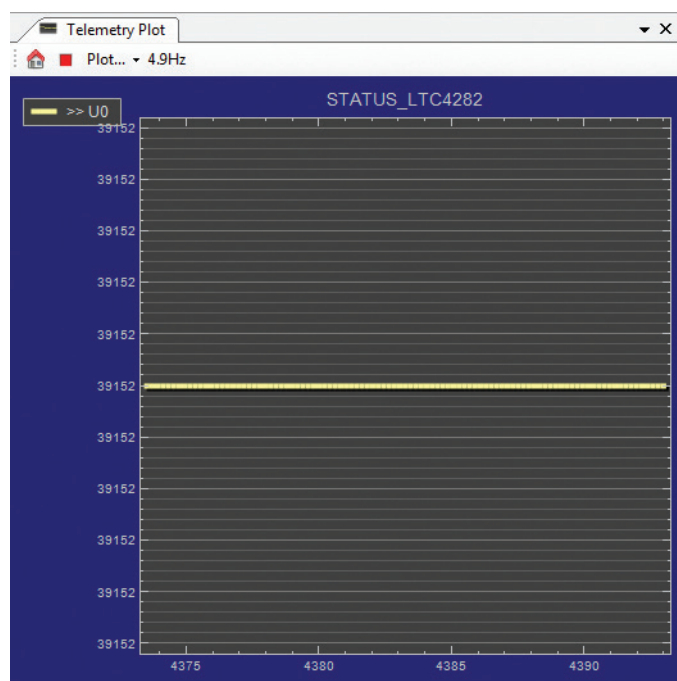

Figure 10. Telemetry Plot Pane

### LTC4282 Registers

The LTC4282 is highly configurable through its register set. Refer to the LTC4282 data sheet for a complete discussion of the registers and functions available. Get immediate access to detailed help for the selected register in LTpowerPlay by pressing the F1 key on your keyboard. Exercise extreme caution when reconfiguring the register set as this board comes preprogrammed to work with the 200A application and changing registers could cause adverse effects and unknown failures.

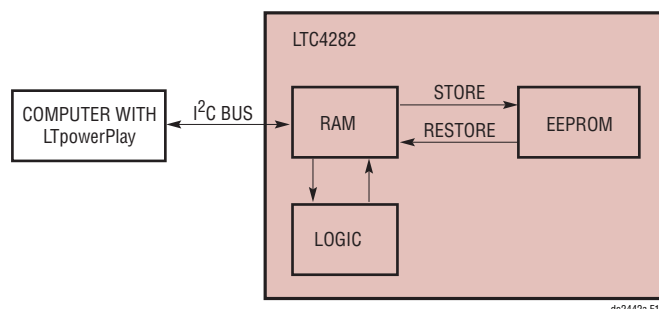

Figure 11. LTC4282 RAM and Nonvolatile Memory

The LTC4282 features an EEPROM nonvolatile memory that holds device configuration information and a snapshot of past fault information. When the part receives power, it executes a power-on reset, and restores the contents of the EEPROM to its operating RAM memory. Following this power-on restore, operating RAM memory can be modified with I<sup>2</sup>C bus commands that modify the part behavior. These modifications are affected by using the PC > RAM button in the tool bar. Also included in the toolbar are buttons for reading the internal RAM data on the PC by using the PC < RAM button on the tool bar. Similarly, there are buttons for moving the contents of the RAM to the NVM (EEPROM) and vice versa using the RAM > NVM and RAM < NVM buttons on the toolbar.



Figure 12. Data Transfer Buttons to Transfer Data to and from Nonvolatile Memory

**WARNING:** The LTC4282 comes preprogrammed in the Low Stress Staged Start configuration with specific settings, which support a 200A application. Changing the LTC4282's programming on the DC2442 is strongly discouraged to ensure safety and proper operation of the board. Exercise caution if changing register settings and refer to Table 7 for key register settings, which should remain untouched.

# DEMO MANUAL DC2442A

---

## DEMONSTRATION BOARD IMPORTANT NOTICE

Linear Technology Corporation (LTC) provides the enclosed product(s) under the following **AS IS** conditions:

This demonstration board (DEMO BOARD) kit being sold or provided by Linear Technology is intended for use for **ENGINEERING DEVELOPMENT OR EVALUATION PURPOSES ONLY** and is not provided by LTC for commercial use. As such, the DEMO BOARD herein may not be complete in terms of required design-, marketing-, and/or manufacturing-related protective considerations, including but not limited to product safety measures typically found in finished commercial goods. As a prototype, this product does not fall within the scope of the European Union directive on electromagnetic compatibility and therefore may or may not meet the technical requirements of the directive, or other regulations.

If this evaluation kit does not meet the specifications recited in the DEMO BOARD manual the kit may be returned within 30 days from the date of delivery for a full refund. **THE FOREGOING WARRANTY IS THE EXCLUSIVE WARRANTY MADE BY THE SELLER TO BUYER AND IS IN LIEU OF ALL OTHER WARRANTIES, EXPRESSED, IMPLIED, OR STATUTORY, INCLUDING ANY WARRANTY OF MERCHANTABILITY OR FITNESS FOR ANY PARTICULAR PURPOSE. EXCEPT TO THE EXTENT OF THIS INDEMNITY, NEITHER PARTY SHALL BE LIABLE TO THE OTHER FOR ANY INDIRECT, SPECIAL, INCIDENTAL, OR CONSEQUENTIAL DAMAGES.**

The user assumes all responsibility and liability for proper and safe handling of the goods. Further, the user releases LTC from all claims arising from the handling or use of the goods. Due to the open construction of the product, it is the user's responsibility to take any and all appropriate precautions with regard to electrostatic discharge. Also be aware that the products herein may not be regulatory compliant or agency certified (FCC, UL, CE, etc.).

No License is granted under any patent right or other intellectual property whatsoever. **LTC assumes no liability for applications assistance, customer product design, software performance, or infringement of patents or any other intellectual property rights of any kind.**

LTC currently services a variety of customers for products around the world, and therefore this transaction **is not exclusive**.

**Please read the DEMO BOARD manual prior to handling the product.** Persons handling this product must have electronics training and observe good laboratory practice standards. **Common sense is encouraged.**

This notice contains important safety information about temperatures and voltages. For further safety concerns, please contact a LTC application engineer.

Mailing Address:

Linear Technology  
1630 McCarthy Blvd.  
Milpitas, CA 95035

Copyright © 2004, Linear Technology Corporation